

UM.4.CN.1.5334

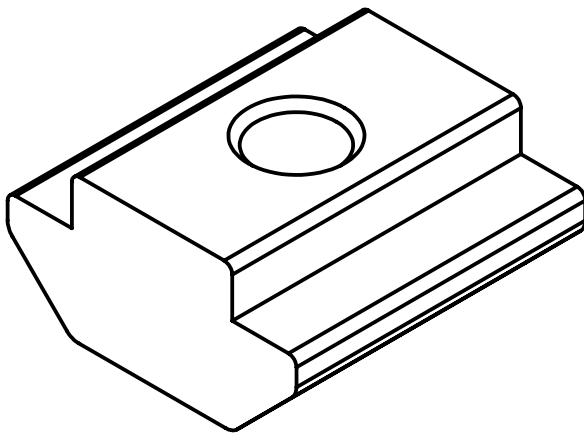
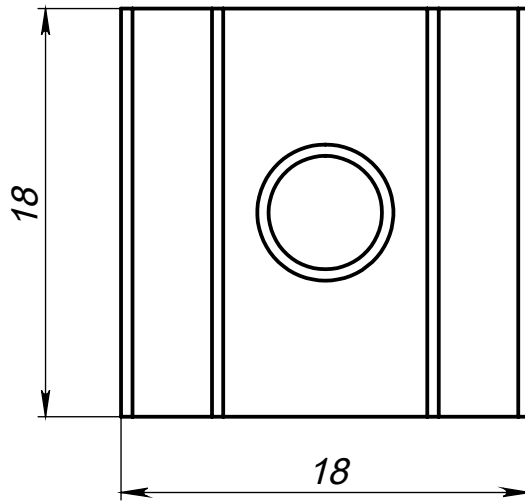
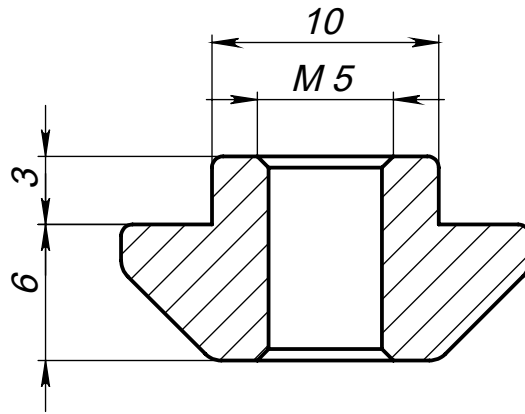

Инв. № подл.	Подп. и дата	Взам. инв. №	Инв. № дубл.	Подп. и дата

Изм.	Лист	№ докум.	Подп.	Дата

UM.4.CN.1.5334

Лист  
1